

garage**wise**
ADVANCED DOOR CONTROL SYSTEM



THE FUTURE IS NOW

DO THIS FIRST BEFORE INSTALLING

Check Your Garage Door Opener Compatibility

NOTE: Not intended to be used on older garage door openers manufactured before 1993 that DO NOT use safety beams.



To determine if this product will work with your opener:

Simulate "pushing the wall console button" by jumping across the terminals using a paper clip at the opener.



If the garage door moves, use the paper clip to then close your garage door and begin the installation process.

genie



If you have a liftmaster or genie garage door opener and it does not open using the jumper, you will need to order one of these DRY Contact Devices to complete installation.

liftmaster



(Order wall button version)



BEFORE INSTALLING the GarageWise security device on your garage door, you must first erase all remotes, keypads, phone apps and Wi-Fi devices from the existing garage door opener if applicable also, any Amazon garage access must be erased. This can be done by going to the amazon.com website, you must sign in, select see all account in the pulldown menu from the sign in icon, select Amazon key settings, then erase all garages.



USE THESE INSTALLATION INSTRUCTIONS and disregard the instruction sheet that was shipped with the dry contact kit.

Installation instructions... #1

Install the Liftmaster dry contact by attaching the wires from the screw terminals behind the switch to the garage door opener, red goes to red white goes to White. Using the remaining two wires connect these wires to the garagewise port hub. After installation, the Garagewise security device must be triggered at least three times by using a remote, keypad, or phone app. This will program the dry contact to the opener. Then use your Garagewise as usual. **DO NOT Press buttons on the dry contact kit**

Installation instructions... #2

For the genie dry contact, connect the opener side of the contact to the opener and the switch side of the contact to the Garagewise port hub.

liftmaster



genie



(Order wall button version)

► **Note: Some of these steps will be repeated in the instruction Manual**



WARNING

DO NOT MISS THIS STEP

▶▶▶ PREPARING DOOR OPENER ◀◀◀

ALL GARAGE DOOR OPENERS USING WI-FI MUST BE REMOVED FROM THE NETWORK AT THIS TIME. (GarageWise will control this feature).
APPS controlling your garage door opener MUST be deleted from all devices.

Find all remotes to your current door opener

Failure to follow the instructions and disable the old remotes / keypads will result in damage to garage door, garage opener, and may cause bodily injury.

Random Code: Unlearn all remotes and keypads following the procedures from the manufacturers manual or on the door opener near the learn button.

Fixed Code: (with dip switches) Remove all batteries from existing remotes, key pad and store away.

CAUTION: YOU MUST NEVER ATTEMPT TO OPERATE THE GARAGE DOOR OPENER WITH YOUR OLD REMOTES, APP, OR KEY-PAD AS LONG AS THE LOCK IS INSTALLED ON THE GARAGE DOOR.

Attempts will jam the lock and door resulting in damage to the door or possibly the door opener.

TO REDUCE THE RISK OF SEVERE INJURY OR DEATH:

READ AND FOLLOW ALL INSTRUCTIONS AND WARNINGS.

1. Install the GarageWise Advanced Locking System only on properly balanced and lubricated garage door. An improperly balanced door may not reverse when required and could result in SEVERE INJURY or DEATH.
2. All repairs if needed, to cables, spring assemblies and other hardware MUST be made by a trained door systems technician BEFORE installing the lock.
3. NEVER connect the GarageWise Advanced Locking System to power source until instructed to do so.
4. NEVER wear watches, rings or loose clothing while installing or servicing lock or opener. They could be caught in garage door, lock, or opener mechanisms.
5. To prevent possible SERIOUS INJURY or DEATH: ALWAYS call a trained door systems technician if garage door binds, sticks, or is out of balance. An unbalanced garage door may not reverse when required.
6. ONLY operate the GarageWise Advanced Locking System and opener at 110VAC 60HZ to avoid malfunction and damage.
7. Without a properly working safety reversal system, persons (*particularly small children*) could be SERIOUSLY INJURED or KILLED by a closing garage door.



DO NOT EVER USE THE OLD OPENER REMOTES OR KEYPAD WHILE THE LOCK IS INSTALLED ON THE DOOR.

IF THE DOOR OPENER DOES NOT ACTIVATE TO OPEN WHEN THE WALL SWITCH, NEW KEYPAD, OR NEW REMOTE BUTTONS ARE PRESSED, **DO NOT ATTEMPT TO USE THE OLD REMOTES, DO NOT ATTEMPT TO BYPASS THE WALL SWITCH OR CROSS CONNECT THE TERMINALS IN EFFORT TO TROUBLESHOOT THE OPENER.**

THE LOCK MUST BE MANUALLY UNLOCKED AND THE OPENER RELEASE CORD OR LEVER MUST BE DISENGAGED BEFORE TROUBLESHOOTING STEPS ARE TAKEN

Table of Contents

2	Garage Door Opener Compatibility
3	Warnings
4	Table of Contents / FCC Compliance
5	Kit Contents
6	Included Hardware
7	Installation
8	Installation
9	indoor Wall Console Instructions
10	Outdoor Keypad Instructions
12	Remote Control Instructions
13	The Phone APP
17	Troubleshooting

FCC Caution:

Any Changes or modifications not expressly approved by the response or compliance could void the user's authority to operate the equipment .

This device complies with part 15 of the FCC Rules. Operation is subject to the following two conditions: (1) This device may not cause harmful interference, and (2) this device must accept any interference received, including interference that may cause undesired operation,

IMPORTANT NOTE:

FCC Radiation Exposure Statement: This equipment complies with FCC radiation exposure limits set forth for an uncontrolled environment. This equipment should be installed and operated with minimum distance 20 cm between the radiator & your body.

This transmitter must not be co-located or operating in conjunction with any other antenna or transmitter.

Note: This equipment has been tested and found to comply with the limits for a Class B digital device, pursuant to part 15 of the FCC Rules. These limits are designed to provide reasonable protection against harmful interference in a residential installation. This equipment generates, uses and can radiate radio frequency energy and, if not installed and used in accordance with the instructions, may cause harmful interference to radio communications. However, there is no guarantee that interference will not occur in a particular installation. If this equipment does cause harmful interference to radio or television reception, which can be determined by turning the equipment off and on, the user is encouraged to try to correct the interference by one or more of the following measures:

- Reorient or relocate the receiving antenna.
- Increase the separation between the equipment and receiver.
- Connect the equipment to an outlet on a different circuit.
- Consult the dealer or an experienced radio/TV technician for help.
- Increase the separation between the equipment and receiver.



garage**wise**

ADVANCED DOOR CONTROL SYSTEM

Kit contents:

- (1) **GarageWise System** *(with attached wire harness)*
- (1) **Plastic Wire Bracket**
- (1) **Plastic Magnet Bracket**
- (1) **Key FOB**
- (1) **Outdoor Key Pad**
- (1) **Power Supply**
- (1) **Indoor Wall Console**
- (1) **Hardware Kit**



garage**wise**

ADVANCED DOOR CONTROL SYSTEM

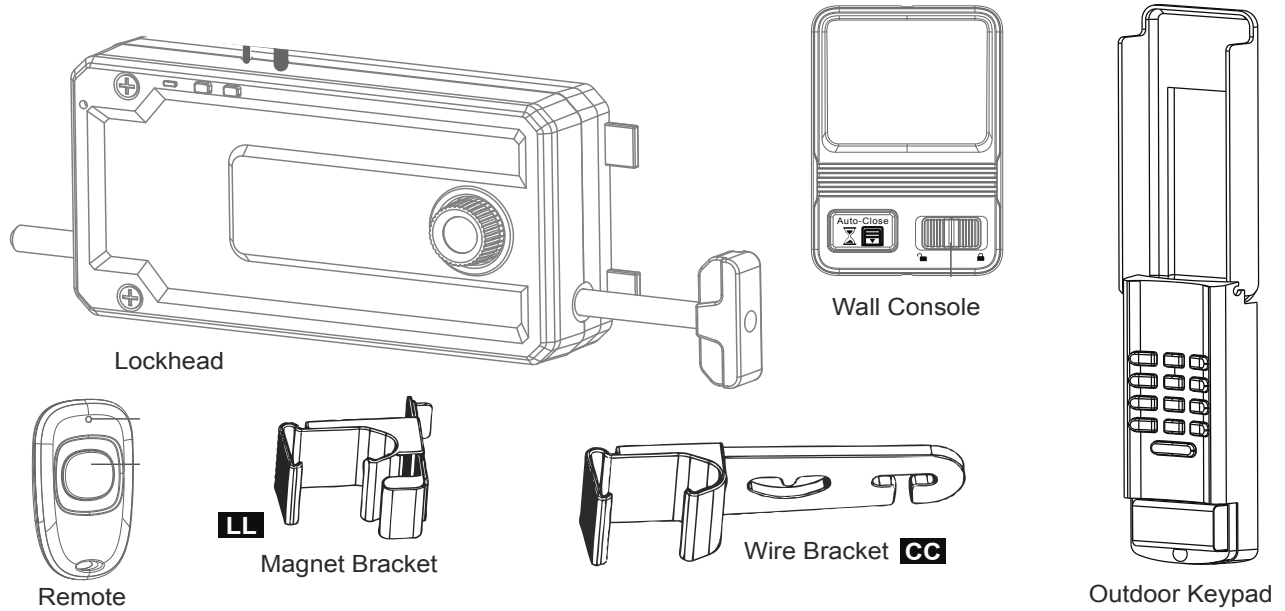

INCLUDED HARDWARE

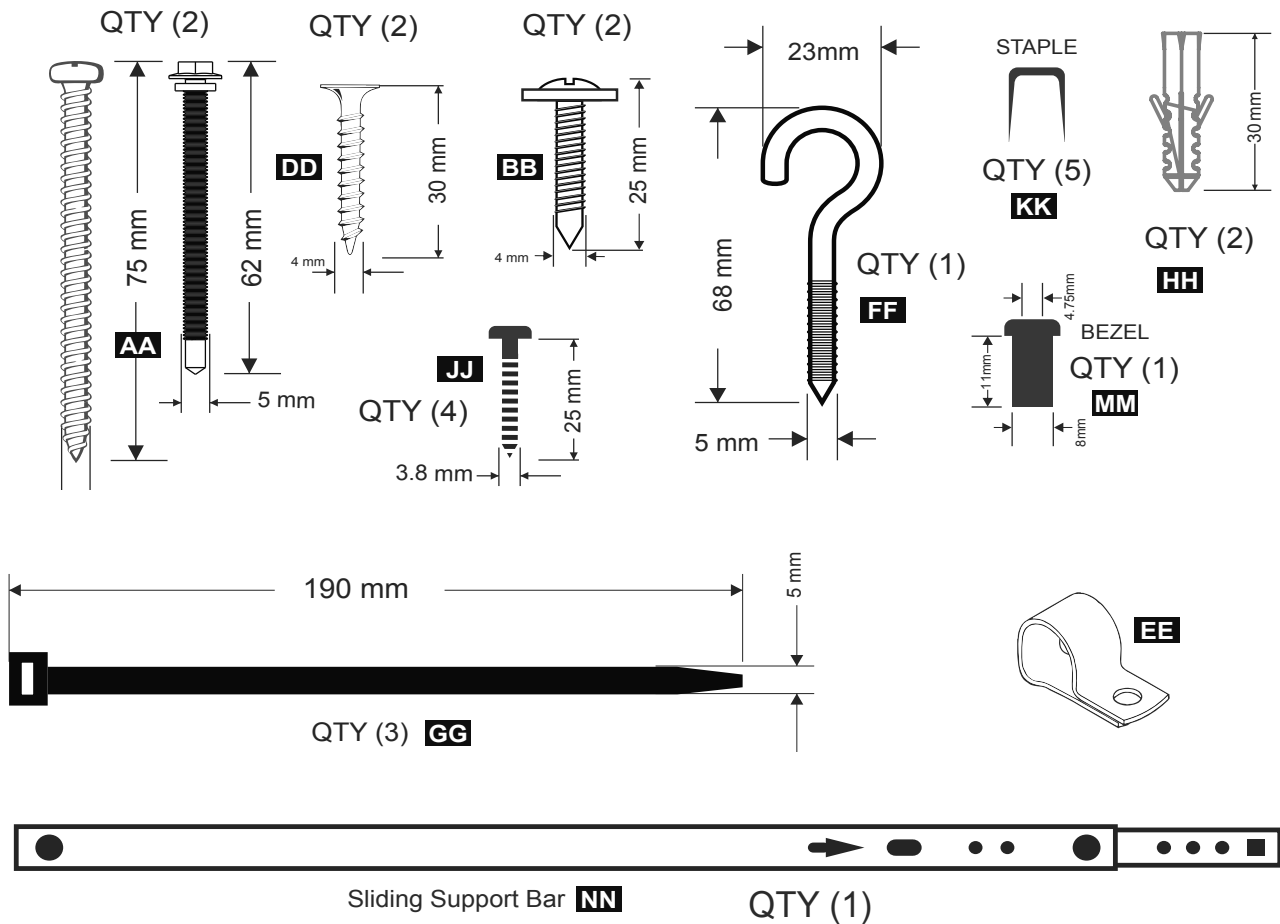

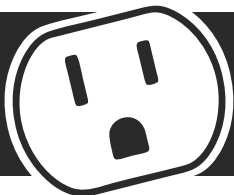

Close garage door using the garage door opener and UNPLUG power to garage door opener!

DO NOT RECONNECT UNTIL INSTRUCTED.

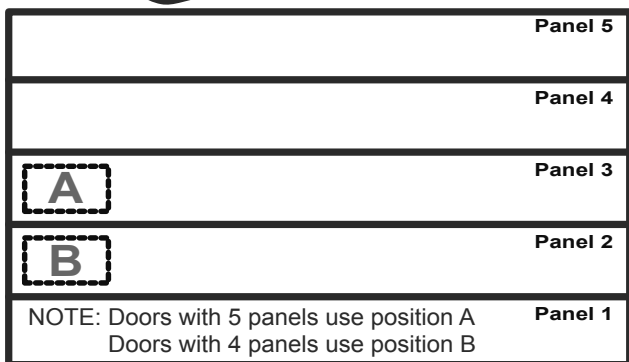

- 1 Always mount the lockhead on the inside left of the garage door
- 2 Use diagram above to determine the panel and location for install
- 3 Locate an existing hole in the track. If one exists, mount the lockhead .25" from the garage door edge in the locked position use 2 [AA] self tapping screws on metal doors (62mm), on wood doors use 2 (75mm) screws.

⚠ CAUTION: DO NOT over-tighten

- 4 Extend the Sliding Support Bar [NN] to fit the garage door panel and install using the 2 [BB] included screws. Ensuring pressure is applied to the 2 plastic tabs on the lock head shown in **diagram (D)**



If lock motor strains after installation is complete. Refer to illustration in troubleshooting section.

- 5 If a hole must be drilled in the track: Mount the lock head in the UNLOCKED position as instructed in step 3, then manually move the deadbolt towards its locked position until it touches the track and make a locating mark. Manually retract the deadbolt to clear the track.

- 6 Pull the release cord on the opener to free garage door and manually lift door to access drill position. After drilling, manually close the door. (**DO NOT re-engage release cord at this time**)

ROUTING THE WIRE HARNESS

- 7 Install the WIRE BRACKET [CC] to the garage door track Reference **diagram (1A)** for location.
- 8 Run coil cord through the bracket as shown in **diagram (2A)** secure with provided zip tie and continue routing along the wall avoiding springs and garage door hardware.
- 9 Secure cord using included plastic one hole Straps [EE] and screws [DD]
- 10 Install the screw hook [FF] 6" to the left and 1" to 3" above the opener bracket on the door header shown in **diagram (B)**

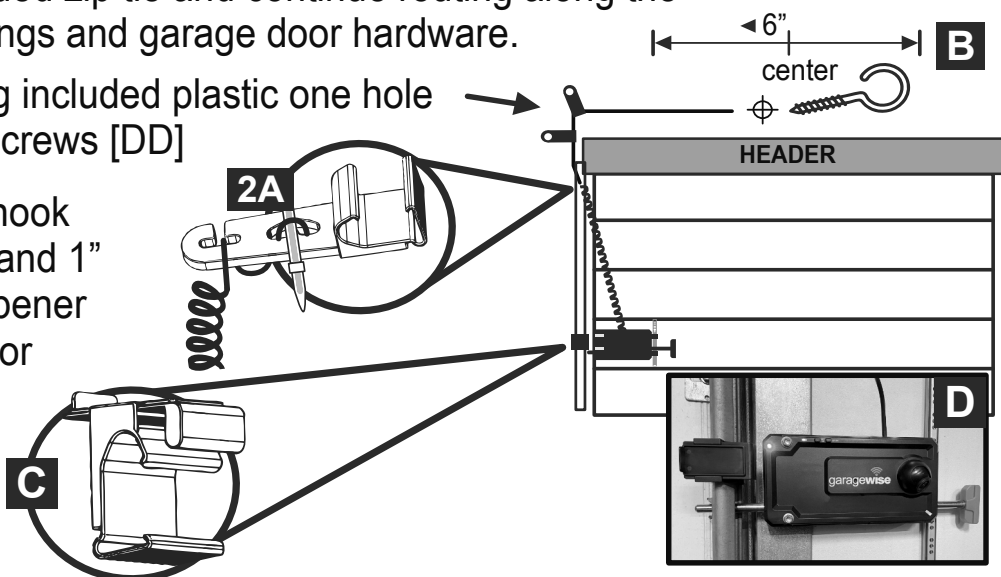
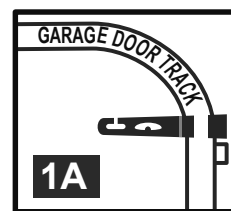

- Take up the slack in the wire and secure it to the screw hook using a ZIP tie [GG]. Fasten the cord to garage opener bracket shown in **diagram (E)** make sure to pull tension to straighten any slack to the hook.

MAKING CONNECTIONS

- Replace the existing wall console with the new one included in the kit. Refer to Indoor Wall Console Mounting instructions page 9. Plug the 2 pin connector from the Wall Console to the Port Hub shown in **diagram (F)**

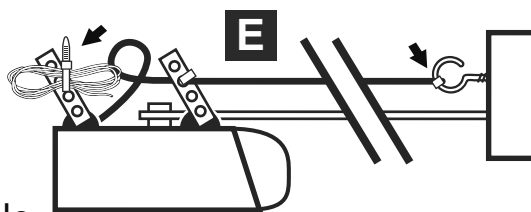

- Cut the existing bell wire coming from the original garage wall console at least 2ft from the garage door opener. Use the piece of bell wire still attached to the opener and connect to the screw terminals shown in **diagram (F)** to the Port Hub.

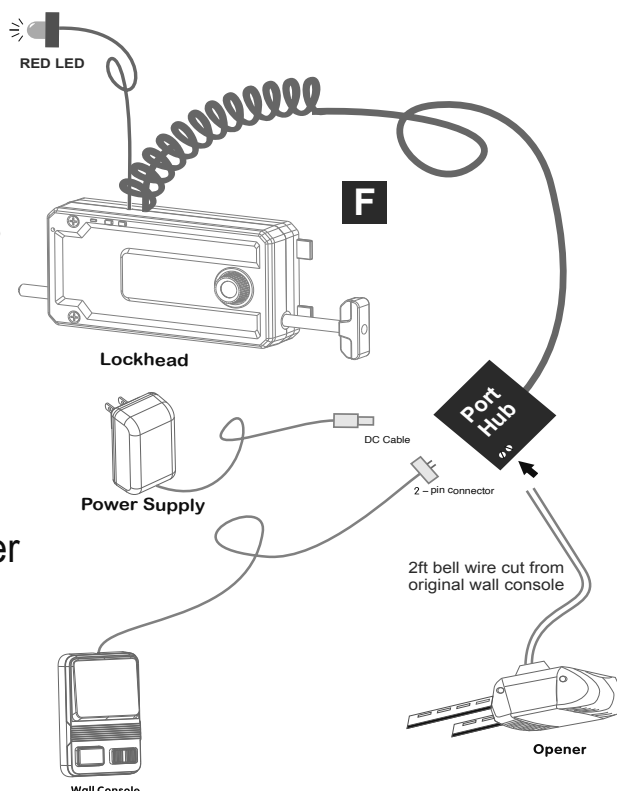

- Bundle and attach excess wire to the garage door opener bracket shown in **diagram (E)**. Use the included zip tie.

- Connect the power supply to the Port Hub shown in **diagram (F)** Then, plug the power supply into a 110VAC outlet. On startup listen for *2 beeps from lock*. Pull opener emergency release cord (Red rope). Now plug the garage door opener into the 110VAC outlet.

INSTALLING MAGNET BRACKET

- Remove the magnet from bracket [LL]. Clip the bracket to the garage door track, between the white marks on the lockhead.

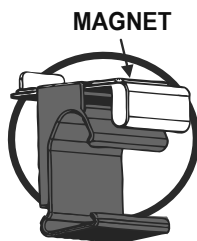

- Insert the magnet fully into the magnet bracket, slide magnet outward. *The lockhead and magnet must not touch.* For correct magnet adjustment PUSH outward on the lock (away from you), then firmly pull the lock towards you. If adjustment is correct, the LED light will not blink and will remain ON. See **diagram (D)**

INSTALLING RED LED



Using wall console, lift the door stopping half way. From the outside, measure no less than 10" and no more than 12" from the right edge of the same door panel as the lock head. Locate a section that is free from decorative design and drill a 5/16" hole. Run the wire through the hole from the inside and attach the bezel [MM] to the LED and push back into hole from outside.

Reconnect garage door release.
Now the installation is complete.

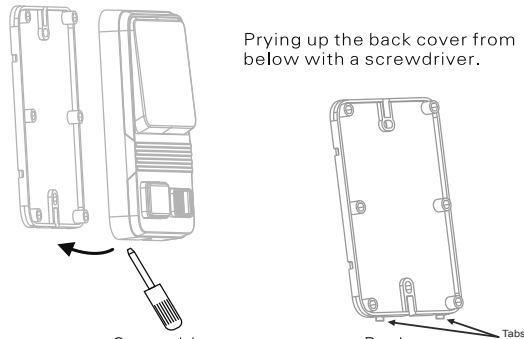
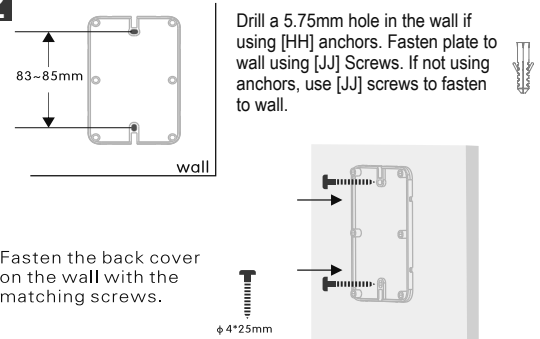
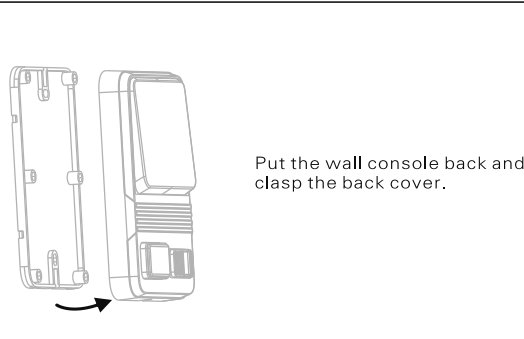
Indoor Wall Console Mounting Instructions

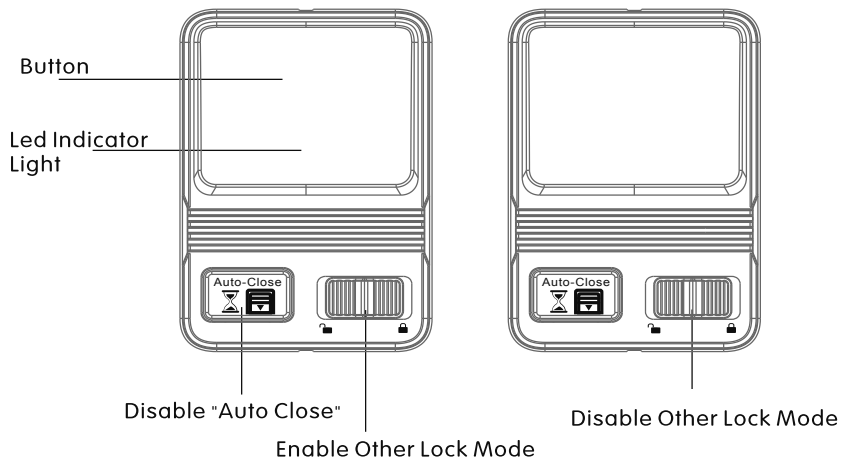
<p>1</p>  <p>Prying up the back cover from below with a screwdriver.</p> <p>Screwdriver</p> <p>Back cover</p> <p>Tab go down</p>	<p>2</p>  <p>Drill a 5.75mm hole in the wall if using [HH] anchors. Fasten plate to wall using [JJ] Screws. If not using anchors, use [JJ] screws to fasten to wall.</p> <p>83-85mm</p> <p>wall</p> <p>Fasten the back cover on the wall with the matching screws.</p> <p>φ4*25mm</p>
<p>3</p>  <p>Put the wall console back and clasp the back cover.</p>	<p>4</p> <p>Run bell wire up wall and across ceiling to Port Hub. Use [KK] insulated staples to secure wire in several places. Do not pierce wire with a staple, create a short or open circuit.</p>

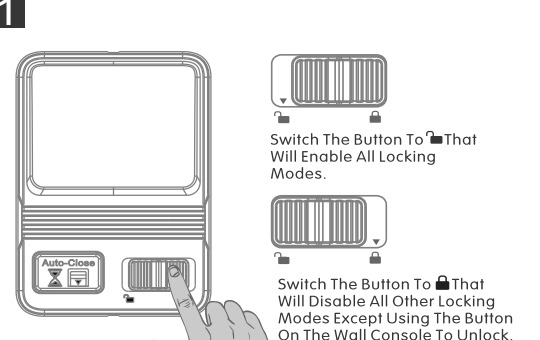

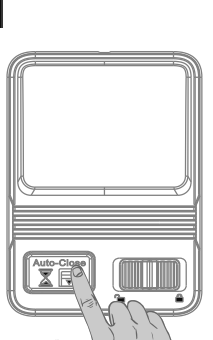
<p>1</p>  <p>Switch The Button To  That Will Enable All Locking Modes.</p> <p>Switch The Button To  That Will Disable All Other Locking Modes Except Using The Button On The Wall Console To Unlock.</p>	<p>2</p>  <p>To temporarily disable "AUTO CLOSE" for one cycle press once after the garage door is open.</p>
--	--

Outdoor Keypad Instructions

! DO THIS FIRST!

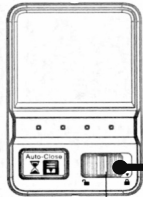

Before pairing remotes, phone app, and outdoor keypad: Make sure the RED SLIDE SWITCH is pushed to the LEFT position of the indoor wall console.

OUTSIDE PANEL CONFIGURATION

1

Short Press "Setup" Button

Press "SETUP" button on the lockhead for (:01) second, the LED will flash green slowly.

2

Press RESET button on the keypad until you hear a "beep", then release. After (5) to (14) flashes the keypad light will remain ON for (:02) seconds.

Complete pairing by pressing 111111 then ENTER. Lockhead will "beep" followed by a solid GREEN or BLUE light.

Remove cover and battery: to access RESET button

ADDING PASSWORD ON OUTSIDE PANEL

3

Short Press "LEARN"

Press "LEARN" button on the lockhead for (:01) second, the LED will flash yellow slowly for (:30) seconds.

4

Enter a 6 digit PIN within the (:30) seconds and press "#" to complete.

? ? ? ? ? ?
"#"

The LED will flicker twice and the lockhead will "beep" twice to confirm.

Using the Outdoor Keypad

1

Enter a 6 digit PIN and press "ENTER" to unlock and open.

? ? ? ? ? ?
"ENTER"

A total of (4) devices can be added to each lock.
Any combination of: remotes and keypads.
(ie: 3 Remotes + 1 Keypad or 2 Remotes + 2 Keypads, etc...)

Outdoor Keypad Instructions

(Continued)

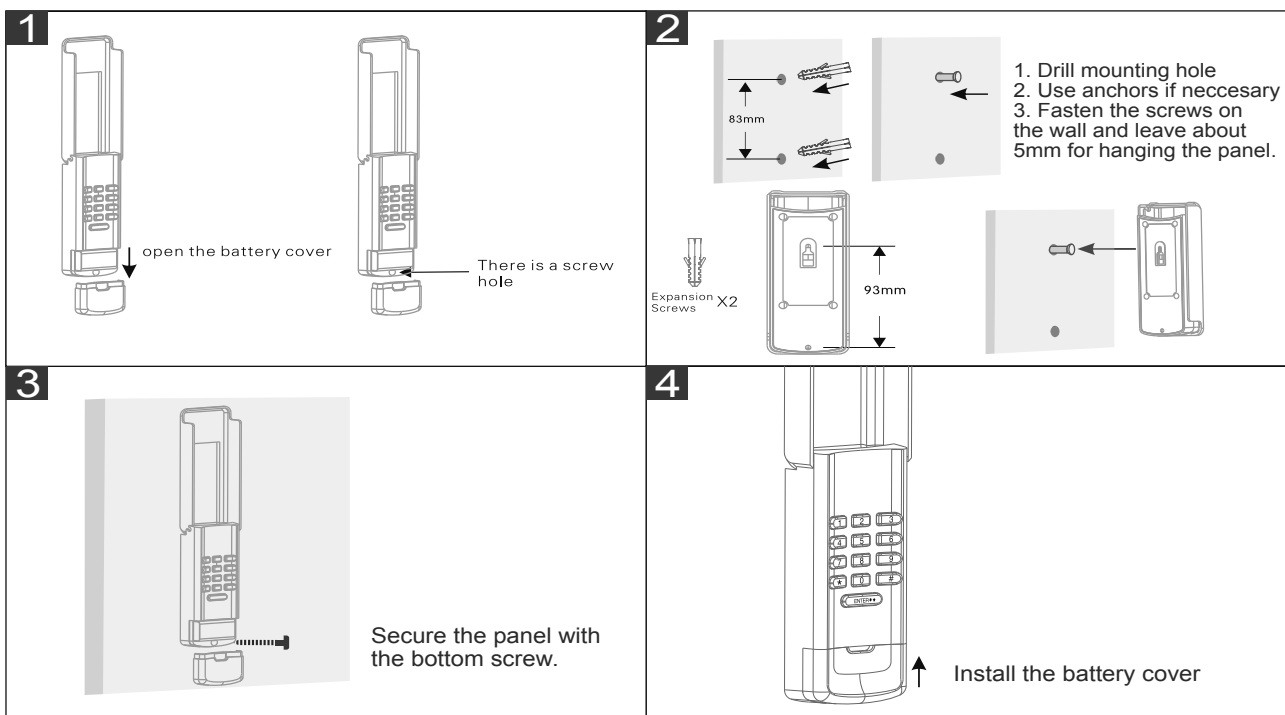
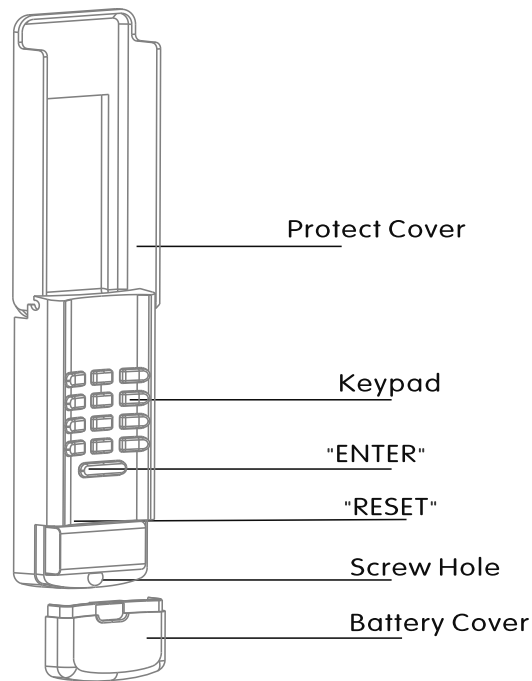

Remote Control Instructions

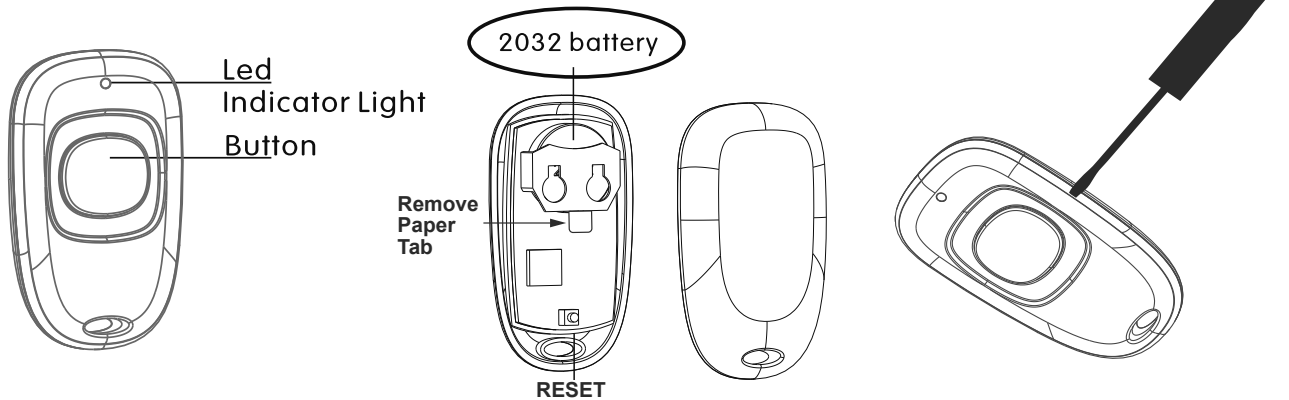

Pairing the remotes

<p>1</p> <p>Short Press "SETUP" Button</p> <p>Press "SETUP" button on the lockhead for (:01) second, the LED will flash green slowly.</p>	<p>2</p> <p>"RESET"</p> <p>Hold the RESET button on the remote circuit board until a short LED flash, continue to hold until the short flashes stop and LED is on for (:02) seconds then release.</p> <p>Release the RESET button</p> <p>The garage door will activate to confirm pairing.</p>
--	---

OPEN THE LOCK WITH REMOTE CONTROL

1

After Con-fig Successfully, User Can Press The Remote Control Button To Unlock

A total of (4) devices can be added to each lock.
Any combination of: remotes and keypads.
(ie: 3 Remotes + 1 Keypad or 2 Remotes + 2 Keypads, etc...)

How to delete all remotes and outdoor keypad.

1

"LEARN"

"SETUP"

Press both "SETUP" & "LEARN" buttons at the same time on the lockhead until the LED starts to blink. There will be a series of beeps and flashes followed by a solid GREEN light indicating all pairing is clear.

The Phone APP

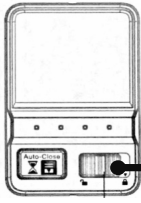

Before pairing remotes, phone app, and outdoor keypad:
Make sure the RED SLIDE SWITCH is pushed to the LEFT position of the indoor wall console.



Make sure to download the official GarageWise App from:
Apple's AppStore or Google Play Store

Create an account if this is your first time using the APP. Follow screen prompts. *If using phone number to signup remember to use "1" before the number for signup, login and sharing.*

⚠ The GarageWise System will only work on the 2.4g side of your home's router. You may need to consult with your ISP (Internet Service Provider) for assistance.

Add device

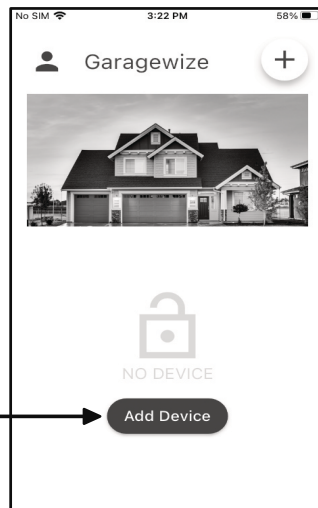

This screen appears after creating your account.

Select "Add Device"

Connect to network

Connect to WIFI using the SSID/ Password on your router

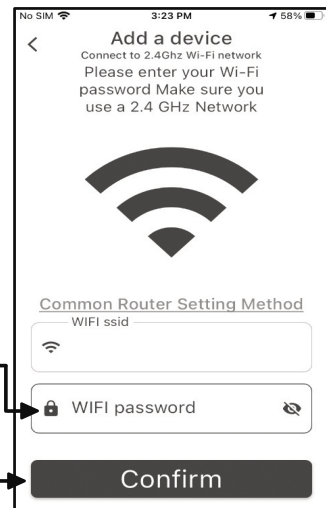

Scan the QR

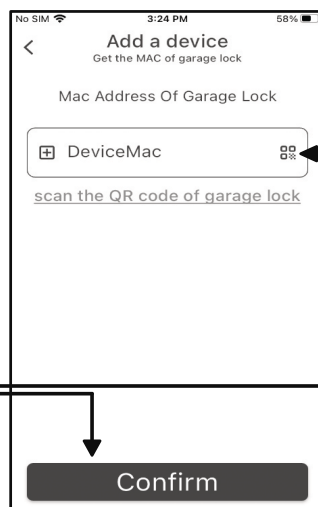

Scan the QR Code on the lock head you are pairing.

Select "Confirm"

Initiate Network

Follow the screen prompts.

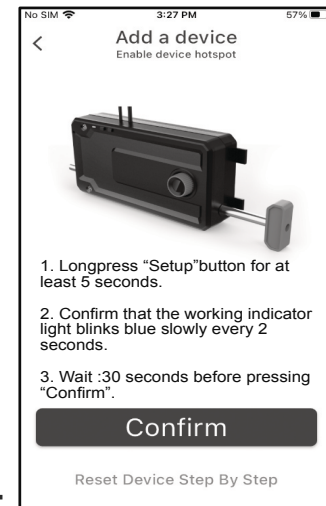

IMPORTANT



Wait :30sec after the BLUE Light begins to flash before pressing "CONFIRM"

Join the network

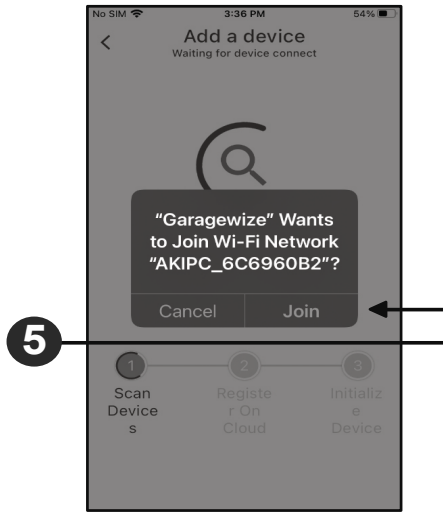

Wait for 3 Checks!

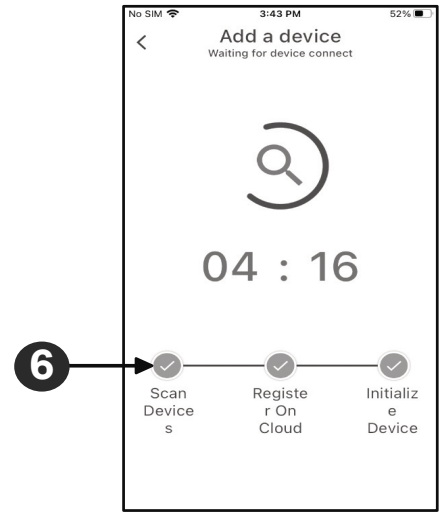

At this stage you can rename your lock head or Select "Confirm" to continue.

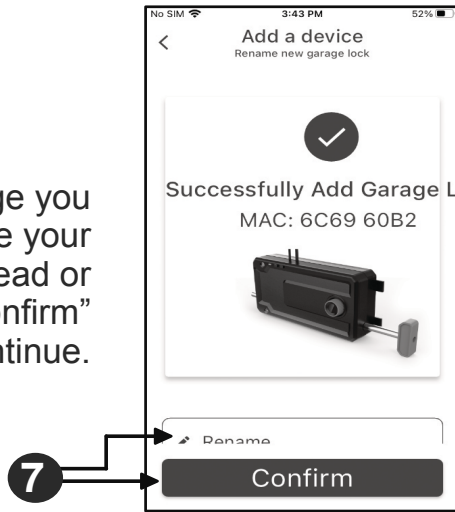

Select the device



To activate camera
 Open/Close Garage door
 Select "Disabled" To access the Auto Close menu and select the desired time.

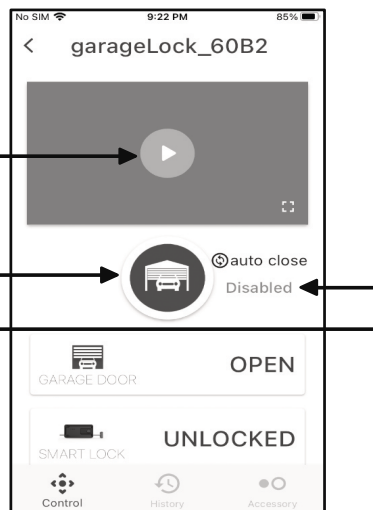

To return to the home screen.

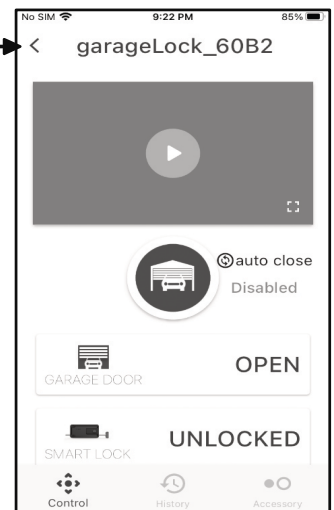

NOTE: scroll up to enter desired time.

- ▶ Repeat steps 1-8 for each additional lock.
- ▶ NOTE: Additional users MUST be invited from this account.

The Phone APP SHARING*

*Can **only** be performed from the **MAIN ACCOUNT**.
(used for initial install)

▶▶▶IMPORTANT◀◀◀

Make sure the person invited downloads the APP and creates an account **first**.

(HOME Screen)

To Share: select the lock with a **LONG PRESS**.

1

2

3

Enter email address or phone number used to create the invitee's account and return to the app to accept.

INVITEE'S PHONE: ACCEPT INVITE

1

Press icon to access the **SHARE SETTINGS**

This screen appears after creating your account.

2

PRESS to access **Share Settings**

3

"Share to Me" Tab

4

After you "Accept" the invite restart the APP.

The Phone APP

DELETING SHARED USERS

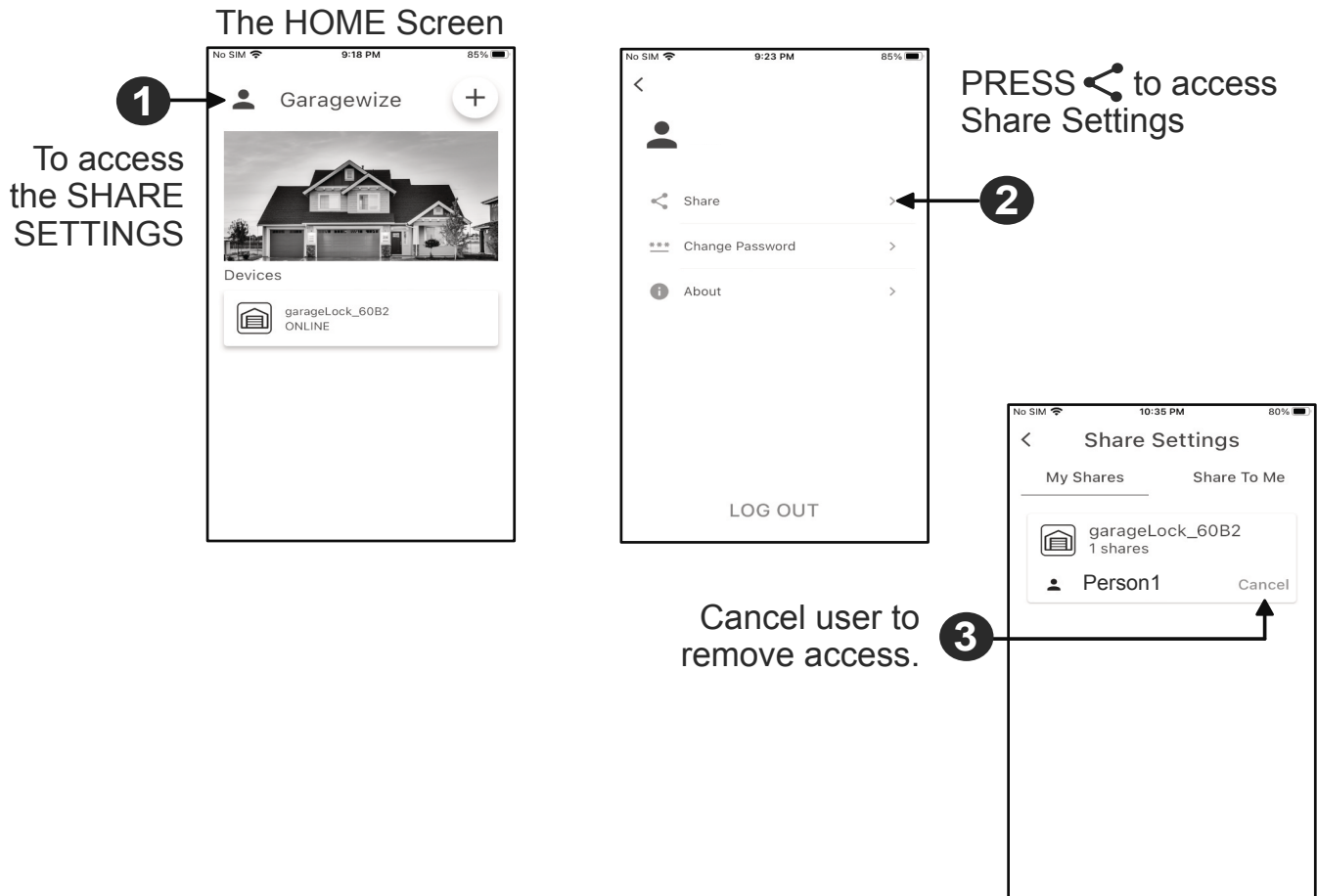

UNPAIR MASTER ACCOUNT

CAUTION: This option cannot be reversed remotely.

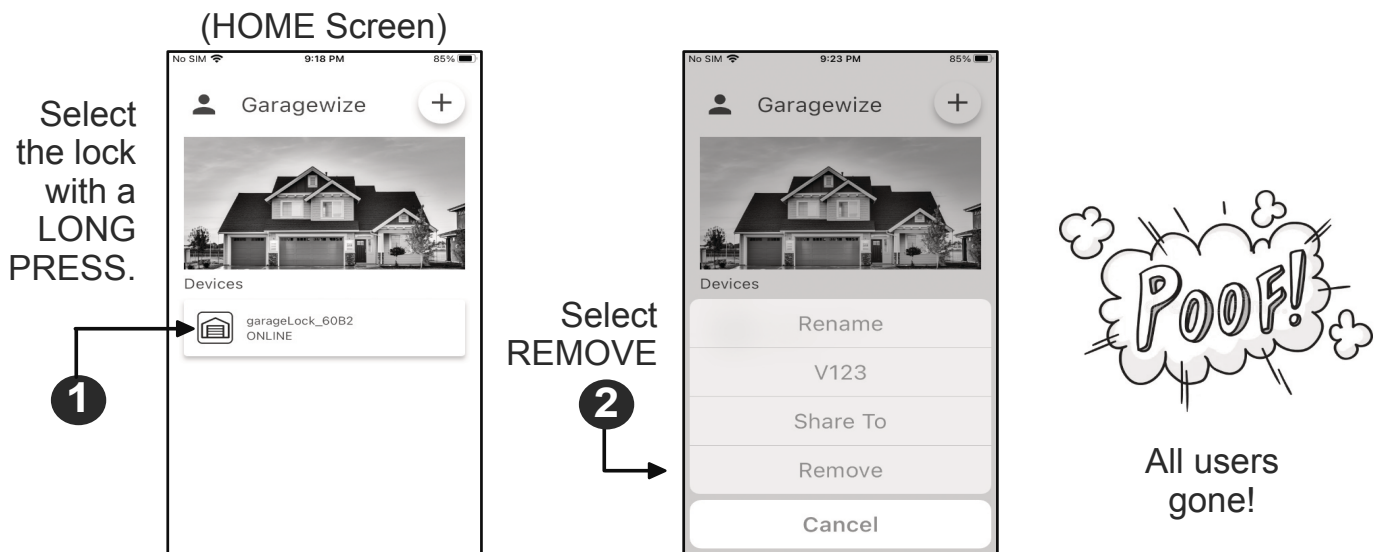





TROUBLESHOOTING

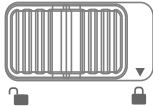
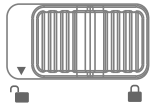

BEFORE TROUBLESHOOTING garage door opener, garagewise system, or garage door (*ie: springs, tables, pulleys, cables*)
(1) PULL RED HANDLE to release the lock **AND (2) REMOVE the MAGNET** from the magnet bracket located on the track.

Re-install and adjust MAGNET after repairs are completed.

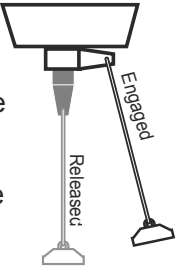
PROBLEM	POSSIBLE CAUSE	REMEDY
APP won't pair	2.4g is not selected on your internet router	Consult with your Internet Provider for assistance or purchase a 2.4g router on Amazon (TL-WA801N)
Remote or Outdoor Keypad won't pair	 Console is in the "LOCKED" position.	 Confirm: Wall Console is in the "UNLOCKED" position.
Status on the App does not change and the lock remains unlocked	 Magnet position preventing operation	Check the magnet position for correct alignment.
The GarageWise deadbolt is mechanically jammed. (<i>not retracted</i>)  This important topic covered on page 3 under "DO NOT MISS THIS STEP"	Due to a false command sent to the garage door opener from a rogue remote or keypad.  	Pull the red release cord on the opener. Then manually pull the red handle on the GarageWise to fully retract the deadbolt. Finally re-engage the manual release cord on the opener. 
Fails or Pairing Errors	Low WIFI strength, poor reception, or NO internet connection.	Reboot both your phone, pad, or other device and your internet connection. (<i>ie: modem, router, and/or switch</i>)
Garage door opener does not work after installation	Bell wire not properly installed into the screw terminals on the Port Hub.	Remove the bell wires and make sure the wires are under the screws in the terminal connector. Retighten screws.
Lock doesn't appear on "shared to phone"		Pull down on phone screen to refresh. Lock should be visible on "HOME SCREEN".

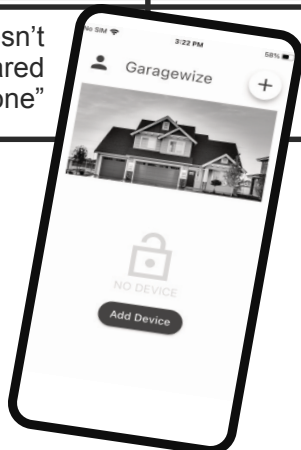

Tech Support:
(866) 274-2724
 Monday - Friday 9a-5p (U.S.A. Mountain time)

TROUBLESHOOTING

PROBLEM	POSSIBLE CAUSE	REMEDY
APP Alert reports: "DOOR OPEN/ LOCK LOCKED	The magnet (on track) is out of adjustment	Insert the magnet fully into the magnet bracket,slide magnet outward. The lockhead and magnet must not touch. For correct magnet adjustment PUSH outward on the lock (away from you), then firmly pull the lock towards you. If adjustment is correct, the LED light will not blink and will remain ON.

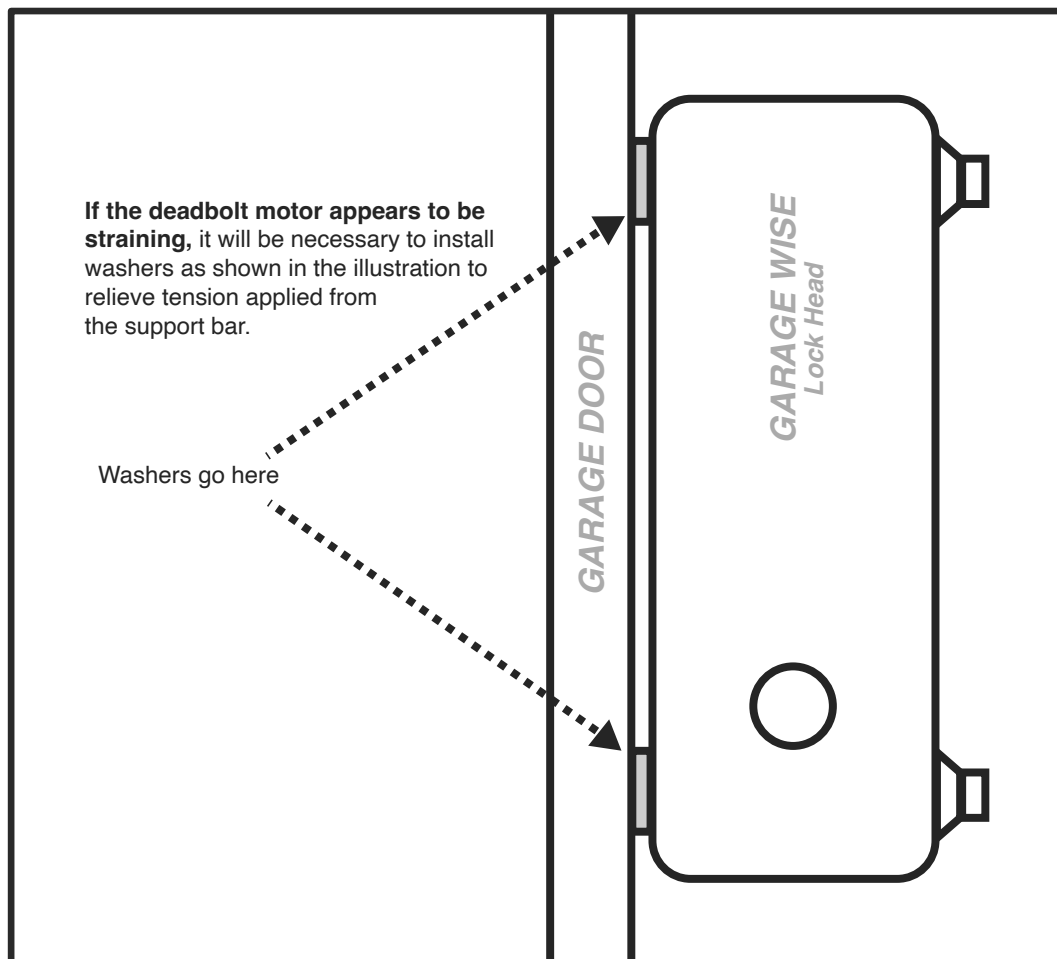



garage**wise**

ADVANCED DOOR CONTROL SYSTEM